

The Drive & Control Company

Rexroth
Bosch Group

Pressure relief valve,
direct operated

Type DBD

RE 25710

Edition: 2016-07

Replaces: 03.13



- ▶ Size 4
- ▶ Component series 1X
- ▶ Maximum operating pressure 500 bar
- ▶ Maximum flow 20 l/min

Features

- ▶ Screw-in cartridge valve
- ▶ 8 pressure ratings
- ▶ 2 adjustment types, optionally:
 - Grub screw with internal hexagon
 - Hand wheel

Contents

Features	1
Contents	1
Ordering code	2
Function, section, symbol	3
Technical data	4
Characteristic curves	5
General information	5
Dimensions	6
Mounting cavity	7

Type-examination tested safety valves type DBD...K according to Pressure Equipment Directive 2014/68/EU

(in the following shortly PED)

Ordering code	8
Deviating technical data	8
Safety instructions	9
Characteristic curves	9, 10
Further information	11

RD 25710, edition: 2016-07, **Bosch Rexroth AG**

2/12 DBD | Pressure relief valve

Ordering code

01	02	03	04	05	06	07	08	09
DBD		4	K	1X	/		V	*

01	Pressure relief valve, direct operated	DBD
----	--	-----

Adjustment type for pressure adjustment

02	Grub screw with internal hexagon	S
	Hand wheel	H

03	Size 4	4
----	--------	---

Type of connection

04	As screw-in cartridge valve (cartridge)	K
----	---	---

05	Component series 10 ... 19 (10 ... 19: unchanged installation and connection dimensions)	1X
----	--	----

Pressure rating

06	Set pressure up to 25 bar	25
	Set pressure up to 50 bar	50
	Set pressure up to 100 bar	100
	Set pressure up to 200 bar	200
	Set pressure up to 315 bar	315
	Set pressure up to 350 bar	350
	Set pressure up to 420 bar	420
	Set pressure up to 500 bar	500

Seal material

07	FKM seals	V
	Observe compatibility of seals with hydraulic fluid used. (Other seals upon request)	

Equipment Directive

08	Without type-examination procedure	no code
	Type-examination tested safety valve according to PED 2014/68/EU (see ordering code on page8)	E

09	For further information, see the plain text	
----	---	--

 **Notice:** Preferred types and standard units are contained in the EPS (standard price list).

Function, section, symbol

Pressure valves of type DBD are direct operated pressure relief valves to be installed in block designs. They are used for limiting a system pressure.

The system pressure can be set via the adjustment type (5).

In the initial position the valve is closed. Via control line (1) and poppet (2), the pressure in the main port ① acts on the spring plate (3). If the pressure in the main port ① rises above the value set at the compression spring (4), the poppet (2) opens and the hydraulic fluid flows into the main port ②.

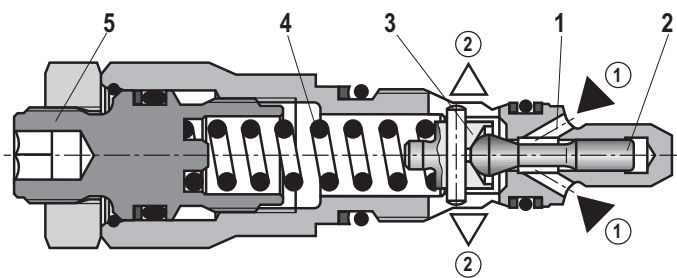

Type DBDS 4 K1X/V

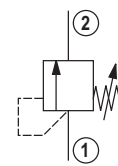

- ① = Main port 1 (P)
- ② = Main port 2 (T)

4/12 DBD | Pressure relief valve

Technical data

(For applications outside these parameters, please consult us!)

general				
Weight	kg	Approx. 0.3		
Installation position	Any			
Ambient temperature range	°C	-20 ... +80		
hydraulic				
Maximum operating pressure	▶ Input	bar	500	
	▶ Output	bar	315 (50 bar at set pressure 500 bar)	
Maximum set pressure	bar	25; 50; 100; 200; 315; 350; 420; 500		
Maximum flow	l/min	20		
Hydraulic fluid	See table below			
Hydraulic fluid temperature range	°C	-20 ... +80		
Viscosity range	mm ² /s	10 ... 800		
Maximum admissible degree of contamination of the hydraulic fluid; Cleanliness class according to ISO 4406 (c)	Class 20/18/15 ¹⁾			
Hydraulic fluid	Classification	Suitable sealing materials	Standards	Data sheet
Mineral oils	HL, HLP	NBR, FKM	DIN 51524	90220
Bio-degradable	▶ Insoluble in water	HETG	ISO 15380	90221
		HEES		
	▶ Soluble in water	HEPG	FKM	



Important notes on hydraulic fluids:

- ▶ For more information and data on the use of other hydraulic fluids, please refer to the data sheets above or contact us.
- ▶ There may be limitations regarding the technical valve data (temperature, pressure range, life cycle, maintenance intervals, etc.).
- ▶ The ignition temperature of the hydraulic fluid used must be 50 K higher than the maximum solenoid surface temperature.

- ▶ **Bio-degradable and flame-resistant:** If this hydraulic fluid is used, small amounts of dissolved zinc may get into the hydraulic system.

¹⁾ The cleanliness classes specified for the components must be adhered to in hydraulic systems. Effective filtration prevents faults and simultaneously increases the life cycle of the components.

For the selection of the filters, see www.boschrexroth.com/filter.

Characteristic curves

(measured with HLP46, $\vartheta_{oil} = 40 \pm 5 \text{ }^\circ\text{C}$)

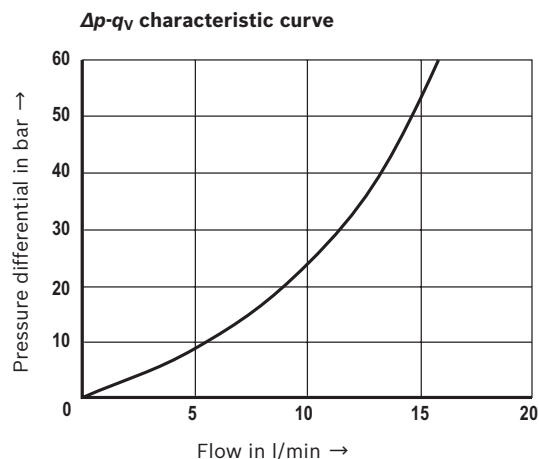
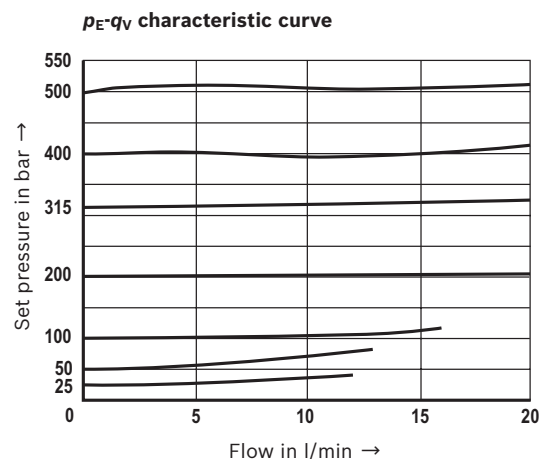

Notes:

The characteristic curves apply to output pressure = zero in the entire volume flow range and were measured without housing resistance.

General information

Hydraulic counter pressures in the main port ② (T) add 1:1 to the response pressure of the valve set at the adjustment.

Example:

- ▶ Pressure adjustment of the valve due to spring preload (item 4 on page 3) $p_{spring} = 200 \text{ bar}$
- ▶ Hydraulic counter pressure in the main port ② (T):
 $p_{hydraulic} = 50 \text{ bar}$

⇒ Response pressure = $p_{spring} + p_{hydraulic} = 250 \text{ bar}$

6/12 DBD | Pressure relief valve

Dimensions (dimensions in mm)

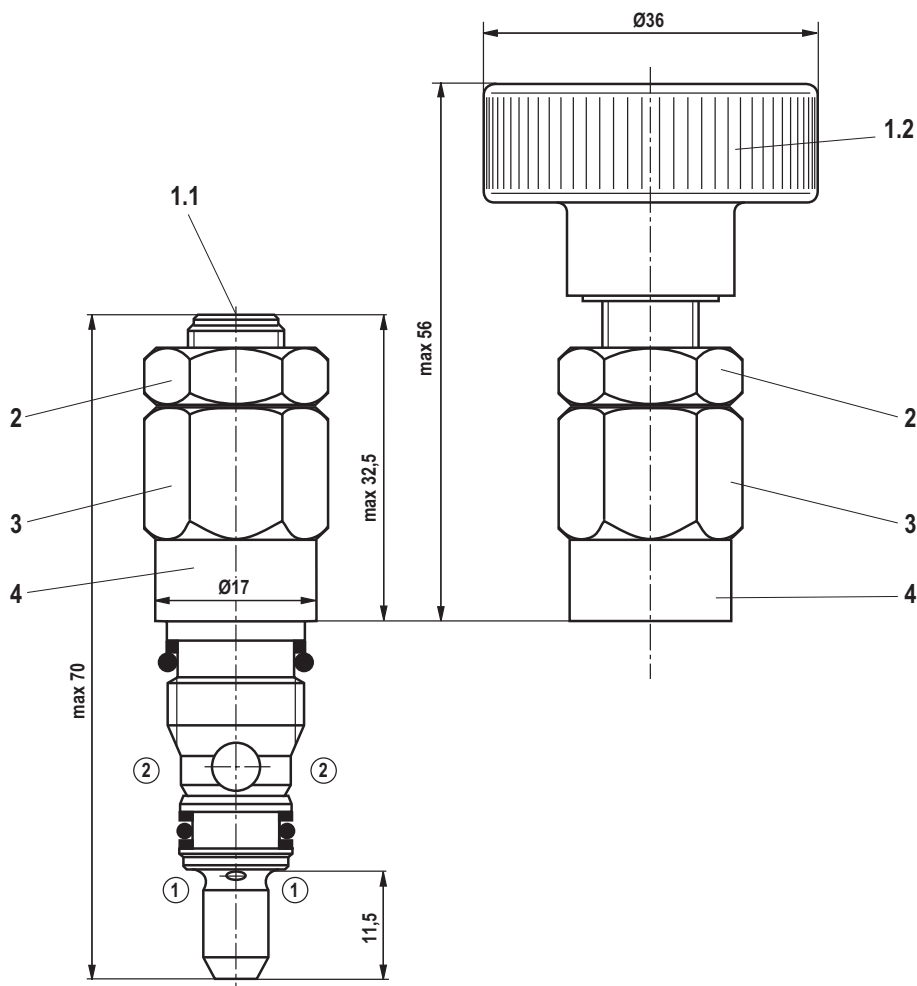

- 1.1 Adjustment type "S", internal hexagon SW5
- 1.2 Adjustment type "H", hand wheel
- 2 Lock nut SW17, tightening torque $M_A = 10^{+5}$ Nm
- 3 Hexagon SW17, tightening torque when screwing in $M_A = 23 \pm 2$ Nm
- 4 Embossed type designation

- ① = Main port 1 (P)
- ② = Main port 2 (T)

Bosch Rexroth AG, RE 25710, edition: 2016-07

8/12 DBD | Pressure relief valve

Type-examination tested safety valves

The functionality of these valves corresponds to that of the standard series (see page 3). Valves of type DBD..1X/..E are, however, type-examination tested pressure relief valves according to the Pressure Equipment Directive 2014/68/EU and intended for use as safety valves.

At the factory, the response pressure is set to a fixed maximum value using the adjustment type. Afterwards, the safety valve is sealed.

The safety valves are available with graded response pressures (in 5 bar steps). With valve versions equipped with rotary knob or hand wheel, the valve spring can be unloaded by the user and a response pressure lower than the factory setting can be set without the need of removing the lead seal.

Ordering code: Type-examination tested safety valves type DBD ¹⁾

Designation	Component marking	Maximum flow $q_{V \max}$ in l/min	Set response overpressure p in bar
DBDS 4 K1X/ <input type="checkbox"/> E	TÜV.SV.- <input type="checkbox"/> -1038.4.F.G.p	10	60 ... 315
DBDH 4 K1X/ <input type="checkbox"/> E		17	320 ... 500

Pressure in the type designation is to be entered by the customer, pressure adjustment ≥ 60 bar and possible in 5-bar steps.

Information is entered at the factory

¹⁾ Component series 1X according to the Pressure Equipment Directive 2014/68/EU

Deviating technical data: Type-examination tested safety valves type DBD ¹⁾

general		
Ambient temperature range	°C	-10 ... +60
hydraulic		
Set response pressure	bar	See last figure of the component marking above
Maximum counter pressure in the discharge line	bar	See characteristic curves on page 9 and 10
Maximum flow	l/min	The last but one figure of the component marking attached at the safety valve is always binding, see above. For valve types which have a variable maximum flow depending on the response pressure, the discharge coefficient is specified at this place (see also page 10)
Hydraulic fluid		Hydraulic fluids according to DIN 51524: Hydraulic oils HL and HLP are suitable for safety valves with FKM seals.
Hydraulic fluid temperature range	°C	-10 ... +60
Viscosity range	mm ² /s	12 ... 230

¹⁾ Component series 1X, according to Pressure Equipment Directive 2014/68/EU (For applications outside these parameters, please consult us!)

Bosch Rexroth AG, RE 25710, edition: 2016-07

Safety instructions: Type-examination tested safety valves type DBD ¹⁾

- ▶ Before ordering a type-examination tested safety valve, it must be observed that for the desired **response pressure p** , the maximum admissible **flow q_{Vmax}** of the safety valve must be larger than the maximum possible flow of the system/accumulator to be secured. According to the Pressure Equipment Directive **2014/68/EU**, the increase in the system pressure due to the flow must not exceed 10% of the set response pressure (see component marking on page 8).
 - ▶ The maximum admissible flow q_{Vmax} stated in the component marking must not be exceeded.
 - ▶ Discharge lines of safety valves must end in a risk-free manner. The accumulation of fluids in the discharge system must **not** be possible (see data sheet AD2000 A2).
-  **It is imperative to observe the application notes!**
- ▶ In the plant, the response pressure specified in the component marking is set with a flow of 1 l/min.
 - ▶ The maximum flow stated in the component marking applies for applications without counter pressure in the discharge line (port T).
 - ▶ By removing the lead seal at the safety valve, the approval according to the Pressure Equipment Directive becomes void!
 - ▶ Basically, the requirements of the Pressure Equipment Directive and of data sheet AD2000 A2 have to be observed!
 - ▶ It is recommended to secure type-examination tested safety valves against inadmissible disassembly by means of wiring and sealing with the housing/block (bore available in the adjustment type).

 **Notice:**

The system pressure increases by the counter pressure in the discharge line (port T) due to the increasing flow. (Observe the data sheet AD 2000 A 2, point 6.3!) To ensure that this increase in system pressure caused by the flow does not exceed the value of 10% of the set response pressure, the admissible flow has to be reduced dependent on the counter pressure in the discharge line (port T) (see diagrams on page 9 and 10).

¹⁾ Component series 1X according to the Pressure Equipment Directive 2014/68/EU

Characteristic curves: Counter pressure in the discharge line

In principle, the valve should be operated without counter pressure in the discharge line, if possible. In case of counter pressure in the discharge line, the maximum flow possible is reduced. There is a relationship between maximum counter pressure p_T in the discharge line and flow q_V , which can be seen from the following characteristic curve. Characteristic curves for intermediate values of the response pressure which are not listed must be determined by means of interpolation.

When the flow approaches zero, the maximum counter pressure p_T is in each case 10% of the response pressure. With increasing flow, the maximum counter pressure p_T decreases.

Interpolation of intermediate values from the diagram

1. At the axis p_T , mark 1/10 of the value of p_A .
2. Determine the next lower and the next higher characteristic curve for this point. The point marked at p_T divides the section between lower and higher characteristic curve on the p_T axis with a certain percentage.
3. At the q_{Vmax} axis, divide the section between next lower and next higher characteristic curve in the same percentage as the section at the p_T axis. From the zero-crossing on the q_{Vmax} axis determined in that way, draw a straight line to the value on the p_T axis marked before.
4. Mark the system flow to be secured at the q_{Vmax} axis.
5. Read off the maximum counter pressure for this value using the line at the p_T axis drawn before.

10/12 DBD | Pressure relief valve

Characteristic curves: Counter pressure in the discharge line

Diagram for determining the maximum counter pressure p_T in the discharge line at port T of the valve dependent on the flow q_{Vmax} for valves DBD. 4...1X/...E with different response pressures p_A .

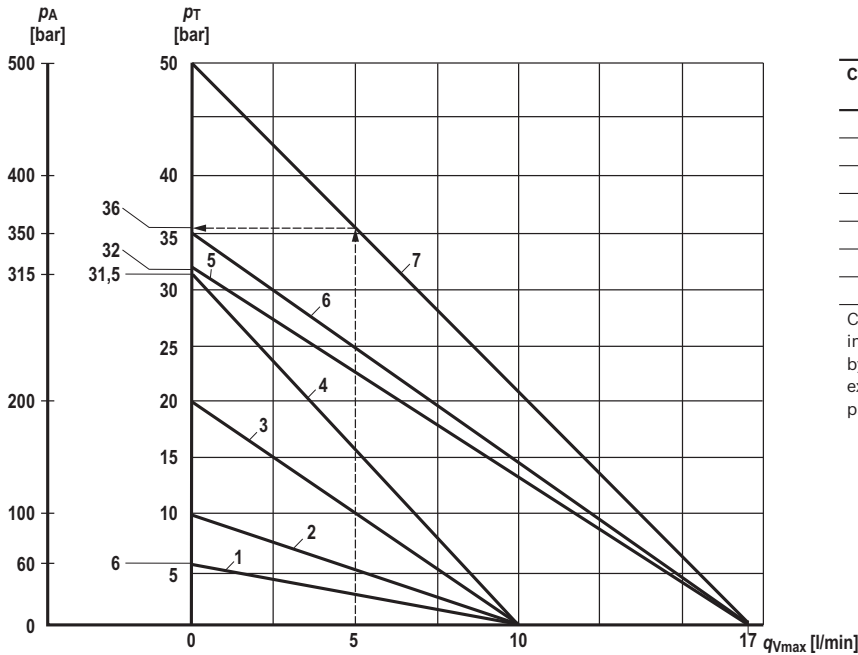

Characteristic curves	Response pressure p_A in bar
1	60
2	100
3	200
4	315
5	320
6	350
7	500

Characteristic curves for intermediate values can be generated by interpolation. Further explanations can be found on page 9.

p_A Response pressure in bar
 p_T Maximum counter pressure in the discharge line (port T) in bar
 q_{Vmax} Maximum flow in l/min

Determination of the maximum counter pressure

Example (with already existing characteristic curve):
Flow of the system / accumulator to be secured: $q_{Vmax} = 5$ l/min
Safety valve set to: $p_A = 500$ bar.
Read off the maximum counter pressure p_T of approx. 36 bar from the diagram (see arrows, characteristic curve 7).

Further information

- ▶ Safety equipment against excessive pressure – safety valves
- ▶ Hydraulic fluids on mineral oil basis
- ▶ Environmentally compatible hydraulic fluids
- ▶ Flame-resistant, water-free hydraulic fluids
- ▶ Flame-resistant hydraulic fluids - containing water (HFAE, HFAS, HFB, HFC)
- ▶ Reliability characteristics according to EN ISO 13849
- ▶ Hydraulic valves for industrial applications
- ▶ Selection of the filters

Data sheet AD 2000 A 2
Data sheet 90220
Data sheet 90221
Data sheet 90222
Data sheet 90223
Data sheet 08012
Operating instructions 07600-B
www.boschrexroth.com/filter