

Analogue indicator type NORIMETER 3 with stepper motor technology, universally applicable in industry, transport technology and shipbuilding



Construction type	Round type NIR3; square type NIQ3
Display principle	Stepper motor principle
Housing sizes	Square: 72x72 mm, 96x96 mm, 144x144 mm Round: Ø 60 mm, Ø 80 mm, Ø 100 mm, Ø 130 mm
Protection class	DIN EN 60529: Front of housing IP66, IP67 and IP68 (1 m, 24 h); rear of housing IP30 (standard, higher on request)
Measured variables	Analogue measurement signals (Voltage, current), Frequency signals, Resistive sensor signals (Pt100/Pt1000, NTC thermistor)
Scale angular	With pointer up to max. 300° (standard 240°)
Class of accuracy	IEC 60051-1: 0.5
Housing material	Glas fibre reinforced, salt spray resistant and uv stabilised plastic; upper part: PC GF10; base plate: PC GF30; face made of lumenized float glass
Illumination	Externally dimmable LED illumination
Supply voltage	18 ... 36 VDC, Other voltages on request



Analogue Indicator NIR3/NIQ3



Scope of application

NORIMETER 3 indicators are mainly used in the Shipbuilding industry, transport technology and mechanical engineering. The indicators fulfill the requirements of the DIN EN 50155 for railway technology and of common ship classification societies and thus, are suitable for applications in harsh environments. Thanks to the mechanical construction, the housing is highly resistant against salt spray and thus, outdoor use is possible. The DIN-compliant housing sizes are suitable for installation in control cabinets and control panels with pre-stamped standardised installation openings.

Display principle

The display on the NORIMETER 3 is via a high-resolution stepper motor with integrated precision transmission at a resolution of 12 steps per degree. A display with a 240° standard scale thus achieves a resolution of the measuring signal in 2880 display steps. The motor itself has a mechanical transmission end stop and an angle of rotation of 315°. This makes a scale angle of up to 300° possible. In addition, a display with a 360° rotating faceplate is available (see data sheet DB-NIQ31).

The motor is controlled by the firmware via a digital filter. This results in an optimum combination of smooth adjustment of the measure value and high precision (without the pointer wavering). The transmission backlash is almost halved by the firmware. This measure allows a display accuracy greater than 0.5% to be achieved relative to the measuring range.

Special features

- Indicator with non-linear scales (spreading scale) available
- Long lifetime due to compact and robust technology, a high protection class and a glass-fibre-reinforced, salt spray resistant plastic housing, suitable for outdoor areas
- Individual scale design and corporate logos possible, even for small quantities
- Option: Available as indicator with 360° rotary faceplate (see datasheet DB-NIQ31) or as indicator with frequency input with integrated direction-of-rotation monitoring
- Option: Minimum-Maximum value indication for saving and indicating the highest and lowest measured value
- Option: Control functionality for sensor failure and power supply failure (Live-Zero)
- Connection for external illumination control as well as separate default brightness setting. On devices with an illuminated pointer it is also possible to set the pointer lighting separately.

Content

Display versions [3]
Standard equipment [▶ 4]
Scale and pointer [▶ 4]
Zero point, pointer return point and measuring range [▶ 6]
Lighting [▶ 6]
Line compensation for temperature display [▶ 7]
Monitoring functions [▶ 7]
Optional special functions [▶ 8]
Signal LED and flashing pointer [▶ 8]
Line compensation [▶ 8]
Min/max display [▶ 9]
Limit value switch output [▶ 9]
Motor with anti-clockwise rotation [▶ 9]
Measured quantities [▶ 10]
Dimensioned drawing, connection diagrams and circuit diagrams [▶ 12]
Technical data [▶ 15]
Type code [▶ 17]
Scale design - order assistance [▶ 19]

Indicator versions

The following figures show the indicator types and sizes:

Housing sizes for Type NIR3 with round design



From left to right: Type NIR3 Ø 60 mm, Ø 80 mm, Ø 100 mm, Ø 130 mm

Housing sizes for Type NIQ3 with square design



From left to right: Type NIQ3 72x72 mm, 96x96 mm, 144x144 mm

Standard version

Scale and pointer

The markings and the graduation of the scale are in accordance with DIN43802 and DIN43780 but can also be customer-specific on request.

Scale and pointer – standard versions (in acc. with DIN 43802 and DIN 43780)		
	White scale dial	Black scale dial
Scaling and scale markings	Black	White
Type of graduation	Coarse-fine graduation	
Scale dial illumination	Scale dial illumination, white	White illumination of scaling and scale markings
Pointer versions	Black pointer, unlit	Illuminated pointer: white, red when lit

Scale – individual versions	
Scale and scale markings	Available in all RAL colours in accordance with customer requirements, own logos possible
Type of graduation	Orientation graduation or any other desired graduation of the scale available according to customer requirements
Scale illumination effects with black scales	Without illumination the scaling and scale markings are white, with illumination the scaling and scale markings are red, green or in another translucent colour

Pointer – individual versions		
Pointer unlighted	Black	
Illuminated pointer	Unlighted: white	Illuminated: White, red, yellow, other colours available on request
	Unlighted: Yellow	Illuminated: Yellow
	Unlighted: Red	Illuminated: Red
	Unlighted: Other colours available on request	Illuminated: Colour selected

Coarse graduation

With this graduation, defined graduation marks are thicker. This allows the values to be better read even at a higher distance.

Orientation graduation

With this graduation, all graduation marks are of equal width.

Example of scales, standard and custom versions

Round design, Type NIR3

Fig. 1

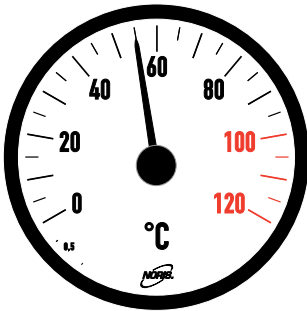

Fig. 2

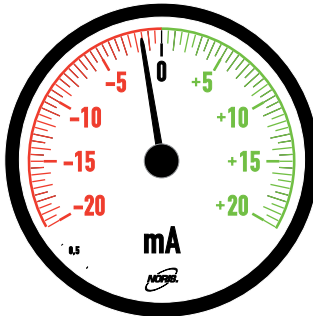

Fig. 3

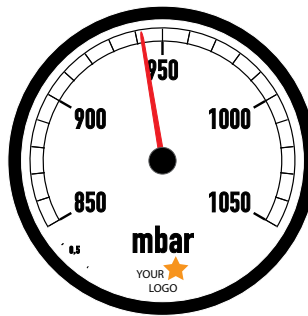

Fig. 4

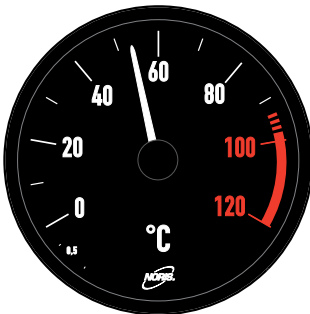

Fig. 5

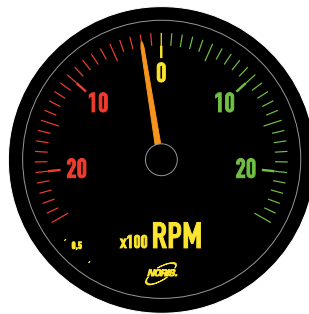
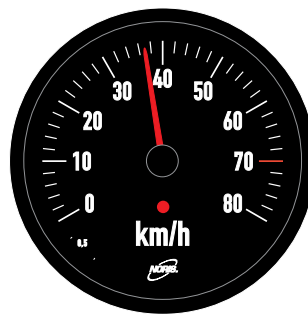

Fig. 6



Square design, Type NIQ3

Fig. 7

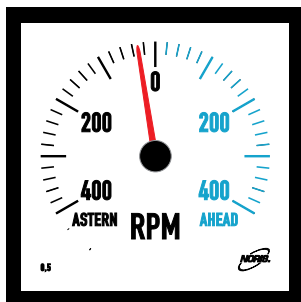

Fig. 8

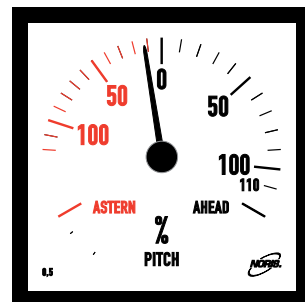

Fig. 9

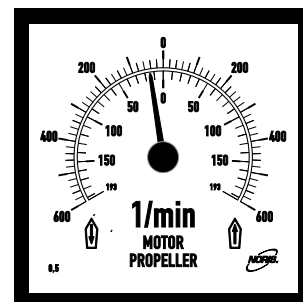

Fig. 10

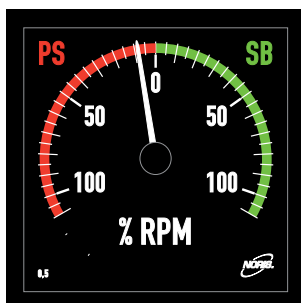

Fig. 11



Fig. 12

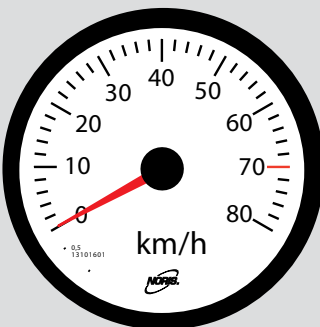
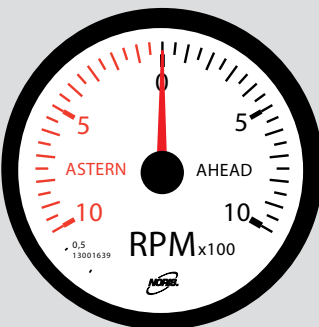
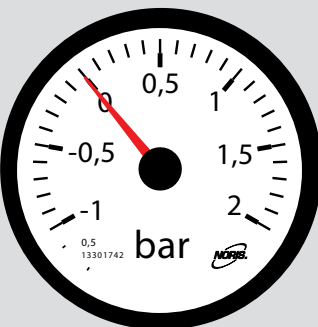
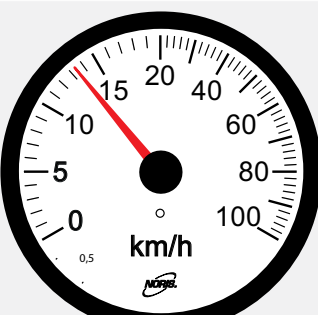

Zero point, return point and scale measuring range

<p>Scale zero point</p>	<p>The position of the scale zero point can be specified as required.</p>		
	<p>Scale zero point on the right (Standard)</p>	<p>Scale zero point in the middle (Standard)</p>	<p>Scale zero point: customer-specific</p>
	 <p>A circular gauge with a scale from 0 to 80 km/h. The zero point is marked at the right edge of the scale.</p>	 <p>A circular gauge with a scale from -10 to 10 RPM x 100. The zero point is marked in the center of the scale.</p>	 <p>A circular gauge with a scale from -1 to 2 bar. The zero point is marked on the left side of the scale.</p>
<p>Return point</p>	<ul style="list-style-type: none"> • When the power is off, the pointer turns to the return point. • The position can be specified as required. • The return point must not be the zero point (e.g. to allow power failures to be detected in the live zero function) 		
<p>Measuring range</p>	<ul style="list-style-type: none"> • Note the difference between the printed measuring range on the scale (can be individually defined) and the signal measuring range (predefined, see type code) • All common standard signals as well as customer-specific signal measuring ranges can be processed. • Scale spread (see figure on the right) and non-linear measuring ranges are available on request. 		<p>Scale spread</p>  <p>A circular gauge with a scale from 0 to 100 km/h. The scale spread is indicated by a red line pointing to approximately 15 km/h.</p>

Illumination

Scale illumination

Scale and illuminated pointer (if integrated) are lit via two separate, controllable systems on an LED basis. The scale is brightly and uniformly lit from the rear via a light panel (transmitted light principle). The power dissipation and thus the intrinsic heat build-up of the indicator is very low. The illuminance can be set between 0 and 100% in 1% steps. The default setting for both illumination systems is 100%.

Three ways to control the brightness:

<p>Setting the default brightness</p>	<ul style="list-style-type: none"> • Setting between 30% and 100% using the two buttons (up/down) on the rear of the indicator housing (allows it to be adapted to suit the default brightness setting of other equipment in the surrounding area) • This setting influences both the scale and the pointer illumination. • The change in brightness is saved in the internal flash memory (even after switching off the supply voltage).
<p>Illumination control via a control signal on the connector</p>	<ul style="list-style-type: none"> • Control of the illumination between zero and the preset default brightness • This setting influences both the scale and the pointer illumination. • Controllable via commercially available 24V dimmer or a DC or AC voltage with any polarity (0...24 V)
<p>Separate adjustment of the illuminated pointer (if installed)</p>	<ul style="list-style-type: none"> • Setting between 30% and 100% using the two buttons (up/down) on the rear (in second button level) • Change of brightness is saved in the flash memory.

Line compensation for temperature indicators

In the indicators with PT100/PT1000 and NTC thermistor inputs, the optional auxiliary function "line compensation" is standard. This allows the display to be individually adapted to suit any signal line resistances that may be present. For further information see also the Datasheet DB-NIR3_NIQ3, section "Optional auxiliary functions".

Monitoring functions

The integrated measuring-signal monitoring detects:

- Total sensor failures, invalid sensor signals
- Broken wire in the sensor cable
- Short circuit in the sensor cable
- Supply voltage failure (only on Live Zero (LZ) units)

The error is shown by:

- Slow flashing of the scale and pointer at maximum brightness
- Pointer turns to a position just outside the valid scale range.

Depending on the measured variable and the indicator type, there are various options available for the monitoring function (see table below).

Indicator type	Operating conditions monitored
U1, U4 U0 (without LZ), I1, I4, I0 (without LZ), F1, F2, FD1, FD2	Measuring signal exceeded
U2, I2, U0 and I0 with LZ	Supply voltage failure, measuring signal exceeded or not reached, short circuit and broken signal line
PT100 / PT1000, NTC thermistor	Measuring signal exceeded or not reached, short circuit and broken signal line

Optional special functions

Special functions can be integrated into NORIMETER 3 indicators upon customer request. Some functions can be combined.

Note: Auxiliary functions that use the indicator's auxiliary port (AUX) cannot be combined.

Note: Optional special functions are not covered by the ordering code in the type code and must be requested in the order text.

Overview of auxiliary functions	Availability
Signal LED coupled to measured value	All types
Flashing pointer coupled to measured value	
Motor with anti-clockwise rotation and right stop	
Signal LED via control signal (AUX)	All types except FD1, FD2, PT100/PT1000 3- and 4-wire
Flashing pointer via control signal (AUX)	Note: Flashing pointer only for types with illuminated pointer
Signal LED coupled to measured value with message memory and manual reset (AUX)	
Flashing pointer coupled to measured value with message memory and manual reset (AUX)	
Minimum/maximum display (AUX)	
Line compensation	Possible for all types; standard in PT100, PT1000 and NTC thermistor types
Limit value switch (AUX)	U1, U2, U4, I1, I2 and I4

Signal LED and flashing pointer

Note: The functional principle required and the application (coupling) must be stated in the order and can then no longer be changed by the customer.

Information on signal LED:

- Red signal LED
- Positioned 2 cm below the pointer spindle
- Available as continuous light or with flashing frequency (2 Hz)
- Auxiliary "flashing pointer" function only available for indicators with illuminated pointers

The application can be selected as follows:

- Coupling to defined measured value, e.g. excessive speed or overtemperature, etc.
- Coupling to one or several measuring ranges, e.g. signal in the red measuring range or message out of the green measuring range. i.a.
- Coupling to measured value or measuring range with message memory:
 - Upon reaching the reporting range and subsequently leaving it, the signal LED remains lit.
 - The display is reset by a signal to the indicator's auxiliary port (e.g. external reset button)
- External control through a signal to the indicator's auxiliary input
- External control with concurrent coupling to a measured value or measuring range

Line compensation

With this optional auxiliary function, two different types of line compensation can be carried out using the buttons on the rear.

1. Proportional line compensation

With proportional line compensation, the value shown on the display can be changed by up to $\pm 10\%$. When measuring voltages for example, this allows a potential voltage drop over the supply lines and the connection terminals to be compensated for.

2. Linear line compensation

With linear line compensation, the display can be changed by up to $\pm 5\%$ of the full-scale value. When using resistive sensors (PT100 / PT1000 or NTC thermistors) for example, this allows the line resistance to be compensated for.

Basically, the "line compensation" function allows the displayed value to be adjusted to match the actual or desired measured value under difficult conditions.

Caution: Line compensation changes the default compensation of the indicator, meaning that the indicator no longer shows the original exact value. The default setting can, however, be reset.

Note: On indicators with PT100, PT1000 or NTC thermistor input, line compensation is standard.

Min/max display

Indicators with this optional auxiliary function register fluctuations of the measuring signal and save the highest and the lowest measured value in the internal measured-value memory. Critical measured values that, for example, occur during the absence of monitoring personnel can therefore be recalled later on. By means of a signal at the indicator's auxiliary port (e.g. via an external button), the saved values can be displayed or deleted.

Note: The min/max data is not permanently saved and is lost when the indicator is switched off.

Limit value switch output

Note: The functional principle of the relay contact and the subsequent assignment of the switching point must be stated in the order and can then no longer be changed by the customer.

Indicators with this auxiliary function have an additional relay card with switching output, with which an external device (e.g. a signal beeper or signalling device, etc.) can be switched.

The switching point of the limit value switch can be selected as follows:

- Coupling of the switching point to a defined measured value, e.g. excessive speed or overtemperature, etc.
- Change to the switching status in one or several measuring ranges, e.g. signal in the red measuring range or signal out of the green measuring range

For further information refer to the specifications for the relay contact in the technical data.

Motor with anti-clockwise rotation

Anticlockwise indicators move the pointer anticlockwise with increasing signal level. This can be expedient for special applications, to show the rudder position and for mirrored displays for example.

Measured quantities

The following measured quantities with the specified signal measurement ranges can be connected directly to type NORIMETER 3 indicators without using additional measuring transducers. Other measured quantities are available on request with additional measuring transducers.

DC voltage

Indicator type	Measurement range
-U1	0...10 V
-U2	2...10 V
-U4	-10 V ...0... +10 V
-U0	Special calibration: freely selectable within the specified range limits below. <ul style="list-style-type: none"> • Minimum range limit: 0 ... 600 mV or -300 mV ...0... +300 mV • Maximum range limit: 0...300 V or -150 V ...0... +150 V For further information please read the technical data.

DC current

Indicator type	Measurement range
-I1	0 ... 20 mA
-I2	4 ... 20 mA
-I4	-20 mA ...0... +20 mA
-I0	Special calibration: freely selectable within the specified range limits below. <ul style="list-style-type: none"> • Minimum range limit: 0 ... 20 µA or -10 µA ...0... +10 µA • Maximum range limit: 0...500 mA or -250 mA ...0... +250 mA For further information please read the technical data.

Frequency

Indicator type	Measurement range
-F1	For square wave signals or other pulsating DC voltages, for AC voltages $\geq 20V_{pp}$, e. g. for active sensors and tachogenerators
-F2	For AC voltages, e. g. for passive sensors (Note: From an amplitude of $\geq 20V_{pp}$ or higher, the type „-F1“ should be used for AC voltages, too)
-FD1	For square wave signals or other pulsating DC voltages with second measuring channel for direction of rotation detection, e. g. for active sensors, but not suitable for tachogenerators
-FD2	For AC voltages with second measuring channel for direction of rotation detection, e. g. for passive sensors and tachogenerators

Measurement range:

0.2 Hz to 140 kHz; Scale end value: ≥ 10 Hz to 140 kHz; frequencies under 0.2 Hz will be show as 0 Hz

Signal form:

All signal forms

Signal level:

Type -F1 or -FD1 (pulsating DC voltage and AC voltages $\geq 20 V_{pp}$): Low level ≤ 4 V, High level $\geq 6,5$ V. Type -F2 or -FD2 (AC voltage): $200 mV_{pp}$ to $400 V_{pp}$. Other signal levels available on request. Please also note the information in the technical data!

Temperature Pt100/Pt1000

Indicator type	Type	Signal measurement range
-Px / -PTx	Pt100 / Pt1000 with two-wire-connection	x=1 [0 ... 120 °C] x=12 [0 ... 100 °C]
PxL3 / PTxL3	Pt100 / Pt1000 with three-wire-connection	x=11 [-30...120 °C] x=2 [0 ... 150 °C] x=3 [0 ... 200 °C]
PxL4 / PTxL4	Pt100 / Pt1000 with four-wire-connection	x=4 [0 ... 250 °C] x=5 [0 ... 300 °C] x=6 [0 ... 400 °C] x=7 [0 ... 500 °C] x=8 [0 ... 600 °C] x=0 [Special calibration freely selectable within the specified range limits]: Start limit: -30 °C ... 0 °C End limit: 50 °C ... 600 °C Example: PT0, measurement range: -10 °C... 220 °C or -5 °C ... 180 °C

Temperature NTC Thermistor

Indicator type	Signal measurement range
-H1	40 ... 120 °C
-H2	5 ... 70 °C
-H3	114 ... 200 °C
-H0	Special calibration: Other signal measurement ranges available on request

Dimensioned drawing, connection diagrams and wiring diagrams

Dimensions of square type NIQ3...

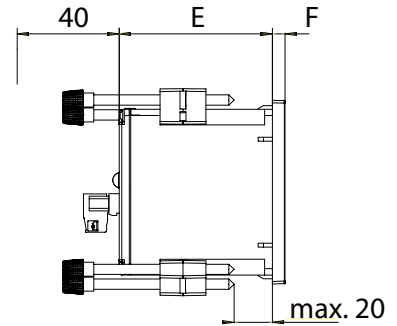
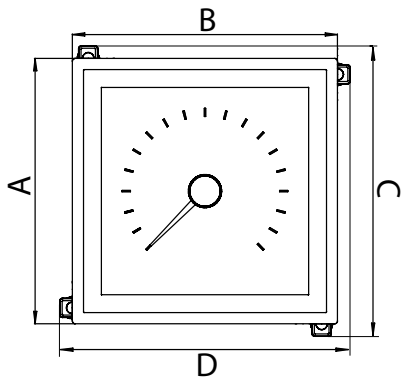

Indicator type	A	B	C	D	E	F	Panel cut-out	Permissible deviation
NIQ3-072...	72	72	81	81	60	5	67.5 x 67.5	+0.5
NIQ3-096...	96	96	105	105	60	5	91.5 x 91.5	+0.8
NIQ3-144...	144	144	153	153	61	8	137.5 x 137.5	+1.0

All values in this table in mm

Dimensions of round type NIQ3...

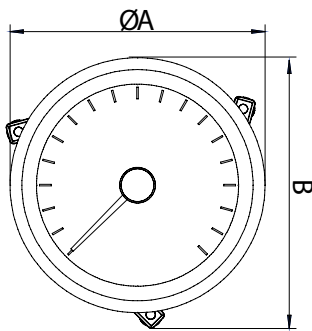

NIR3-060, NIR3-080

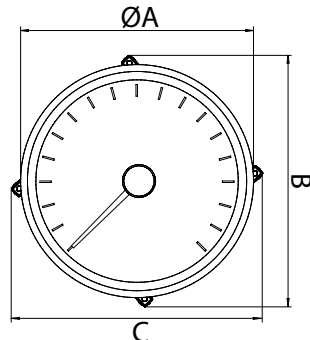

NIR3-100, NIR3-130

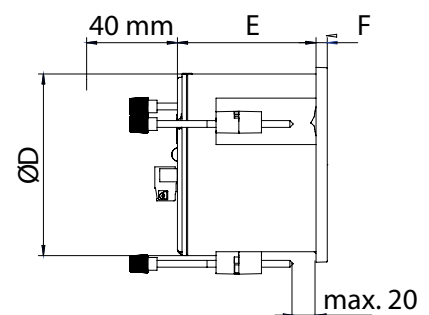

Indicator type	A	B	C	D	E	F	Panel cut-out	Permissible deviation
NIR3-060...	66	71.5	-	60	61	5	Ø 60.5	+0.5
NIR3-080...	86	91.5	-	80	61	5	Ø 80.5	+0.5
NIR3-100...	106	116.5	116.5	100	61	5	Ø 100.5	+0.5
NIR3-130...	136	146.5	146.5	130	63	6	Ø 130.5	+0.5

All values in this table in mm

Connector and pin assignment



1: Nlx3 connector

Pin	Indicator labeling	Description
1	U _s +	Supply voltage +
2	U _s - (0 V)	Supply voltage - (0V)
3	Illum. + (<24V)	Illumination control input, positive (24 VDC)
4	Illum. -	Illumination control input, negative
5	Signal LED / N.C. / Q2 (type-specific)	Auxiliary positive connection
6	24 VDC / N.C. (type-specific)	Auxiliary negative connection
7	Meas. Sign. + (type-specific)	Measuring signal input, positive
8	Meas. Sign. - (type-specific)	Measuring signal input, negative

Connection diagrams

Free pins in the diagrams below are not connected for the respective signal type.

Type -F1

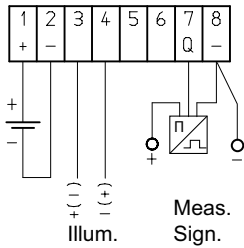

Type -F2

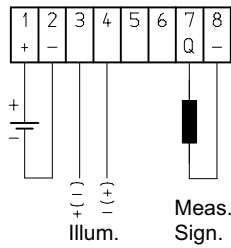

Type -FD1

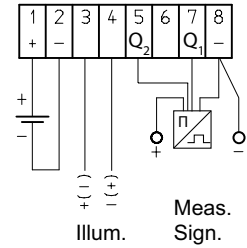

Type -FD2

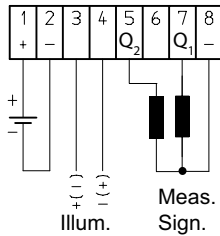

**Type -I1, -I2, -I0
Type -U1, -U2, -U0**

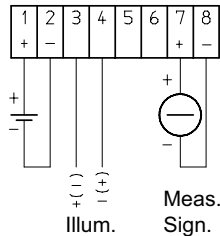

Type -I4, -U4, -UG0,

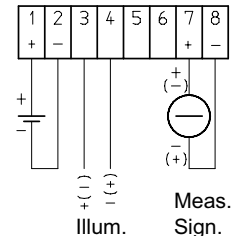

Type -H1, -H2, -H3

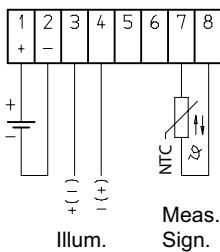

Type -Px, -PTx (2-wire)

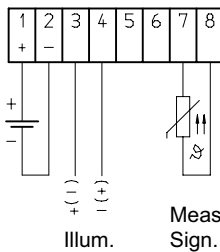

Type PxL3, Type PTxL3 (3-wire)

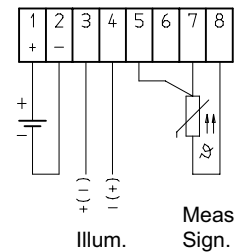

Type -PxL4, -PTxL4 (4-wire)

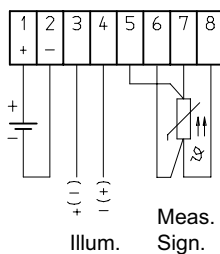

**Connection of relay output
or 24 VDC control input**

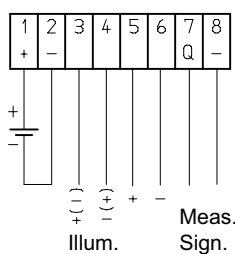

**Connection of
Auxiliary push button**

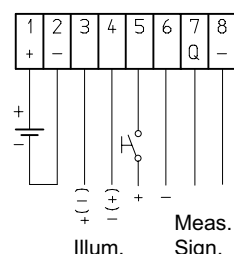

Technical data

Electrical connection	
Supply voltage	18 ... 36 VDC, Other voltages on request
Nominal voltage	24 VDC
Power consumption	2 W maximum
Reverse voltage protection	Yes
Over voltage protection	Yes
Connection	8-pin connector
Galvanic isolation	4 galvanically isolated inputs and outputs

Input signal	
Analogue measurement signals	0...10 VDC (Ri = 29 kΩ); 2...10 VDC; (Ri = 29 kΩ); -10...+10 VDC (Ri = 26 kΩ); 0...20 mA DC (Ri = 121 Ω); 4 ... 20 mA (Ri = 121 Ω); -20 ... +20 mA (Ri = 59 Ω); customer-specific measuring ranges on request
Frequency signals	Frequency range: 0.2 Hz...140 kHz; full-scale value ≥ 10 Hz...140 kHz; < 0.2 Hz is shown as 0 Hz Signal shape: all signal shapes Alternating voltages: 200 mVpp ... 400 Vpp; Pulsating direct voltage: Low level ≤ 4 V; high level ≥ 6.5 V, max. 200 Vp Internal resistance Ri: > 220 kΩ for all signals, 10 kΩ termination available Sensor type options: Active sensors with "open collector" as NPN or PNP output or with push-pull output stage; passive sensors: magnetic induction principle; tachogenerators: with alternating voltage output Note: For "open collector" PNP or NPN sensors without internal pull-up or pull-down resistors, a corresponding 10 kΩ resistor can be switched in the NORIMETER 3 on request.
Resistive sensor signals	Pt100/Pt1000 in 2-, 3- and 4-wire technology; -30 °C ... 600 °C; measuring current Pt100 = 1.6 mA, Pt1000 = 0.17 mA NTC thermistor; H1: 40...120 °C; H2: 5...70 °C; H3: 114...200 °C
Input for illumination control	Commercially available 24 V PWM dimmers (positive or negative regulator) or 0...24 V DC or AC voltage (either polarity); Ri = approx. 17 kΩ
Auxiliary input (binary input)	Binary connection, for external control of alarm LED or blinking pointer; ≤ 5 V = Off (Low); ≥ 9 V up to max. 36 V = On (High)
Auxiliary input (direction-of-rotation monitoring, multi-wire)	Pin 5: Q2 input for direction of rotation signal for frequency indicators with direction of rotation indication (input for wire 3 for PT100 / PT1000 in three-wire or 4-wire technology; Pin 6: input for wire 4 for PT100 / PT1000 in four-wire technology
Auxiliary output (relay output)	Magnetic contact relay, switching contact as normally closed or normally open as operating or closed-circuit current Maximum switch voltage: 110 VDC or 125 VAC Maximum switch current: 1 A at ≤ 30 VDC; 0.5 A at ≤ 125 VAC (at resistive load) Maximum switch capacity: 30 WDC or 62.5 WAC (at resistive load) Maximum contact resistance: 50 mΩ
Class of accuracy	IEC 60051-1: 0.5
Measurement signal resolution	10 Bit
Stepper motor resolution	12 motor steps per angular degree

Environmental influences	
Operating temperature	Reference range of operation: -25 ... +70 °C, nominal range of operation: -25 ... +70 °C
Storage temperature	-40 ... +70 °C (max. peak values within 30 day/year at relative humidity of 5...95%)
Protection class	DIN EN 60529: Front of housing IP66, IP67 and IP68 (1 m, 24 h); rear of housing IP30 (standard, higher on request)
Salt spray resistance	IEC 60068-2-52: Test severity class 1 (open deck) and test severity class 4 (de-icing salt)
Vibration resistance	DIN IEC 60068-T2-6: 4 g, test duration 3 x 90 minutes (at 100 Hz)
Shock resistance	EN 61373 Cat. 2: 5 g at 30 ms; 10 g at 18 ms
Climatic test	IEC 60068-2-1: dry coldness -25 °C, test duration 16 h IEC 60068-2-2: dry heat 70 °C, test duration 16 h IEC 60068-2-30 damp heat ≤ 95% relative at 55 °C, test duration 2 x 12 h
ESD	IEC 61000-4-2 and EN 50121-3-2, Tab. 9.3, evaluation criterion "A": Air discharge 8 kV; contact discharge 6 kV
Burst	IEC 61000-4-4 and EN 50121-3-2 table 7.2 and table 8.2: 2 kV for supply connection, signal connection, data connection and control connection
Surge	IEC 61000-4-5, EN 50121-3-2, Tab. 7.3: US+ to US- with 1.0 kV, Ri = 2 Ω
RF interference immunity	IEC 61000-4-3: 80 MHz...2 GHz, 80% AM with 1 KHz, E = 10 Veff/m EN50121-3-2, Tab. 9.1 und 9.2: 80 MHz...1 GHz, 80% AM with 1 KHz, E = 20 Veff/m 1.4 GHz...2.1 GHz, 80% AM with 1 KHz, E = 10 Veff/m 2.1 GHz...2.5 GHz, 80% AM with 1 KHz, E = 5 Veff/m
Conducted RF interference	IEC61000-4-6 and EN50121-3-2, Tab. 7.1 and 8.1: f = 150 kHz ... 80 MHz at 80 % AM @ 1 kHz, V = 10 Veff
Conducted AF interference	GL2012 GL2003: 50 Hz...10 kHz, V = 3 Veff
Emitted interference	CISPR 16-1, CISPR 16-2 EMC2 EN50121-3-2, Tab. 4: Battery-related connections 150 KHz...30 MHz EN50121-3-2, Tab. 6: Housing 30 MHz...1 GHz
Insulation voltage	1000 VDC between all electrical inputs and outputs

Mechanical variables	
Housing material	Glas fibre reinforced, salt spray resistant and uv stabilised plastic; upper part: PC GF10; base plate: PC GF30; face made of lumenized float glass
Mounting	Fastening screws with dovetail key and hand knob (tool-less)
Installation position	Any
Weight	NIQ3-072: 170 g NIQ3-096: 250 g NIQ3-144: 510 g NIR3-060: 145 g NIR3-080: 185 g NIR3-100: 245 g NIR3-130: 375 g
Housing sizes	Square: 72x72 mm, 96x96 mm, 144x144 mm Round: Ø 60 mm, Ø 80 mm, Ø 100 mm, Ø 130 mm

Other	
Illumination	Externally dimmable LED illumination
Initialising time	Approx. 5 s after switching on the supply voltage
Minimum switch on period	2 minutes to permanently save a changed default brightness setting; 3 minutes so that the pointer returns to the zero point from any position
Scale angular	With pointer up to max. 300° (standard 240°)
Fire protection class	UL94: V0 (all housing parts)
Approvals	CE, ABS, BV, DNV-GL, LR, MED
Further standards	DIN EN 50155 (railway application)

Type code

Type code structure NIR3..., NIQ3...							
NI	Q	3	-072	-F1	-123	-MED	Example NIQ3-072-F1-123-MED
	Housing type						
	Series						
		Housing size					
			Input signal				
				Scale version			
					MED Approval		

Ordering information

- The type code does not show all the options available for the NORIMETER 3 indicator.
- For the indicator types: F1, FD1, F2, FD2, H0, I0, P0, PT0, U0 and UG0, the signal measuring range required must be specified in addition to the type code.
- All optional auxiliary functions required must also be specified in the order text.
- Please note that the coarse scale graduation is standard if not otherwise specified in the order. An orientation graduation or other divergent scale variants must be specified in the order.
- In order to be able to implement the desired scale design, the order has to be supplemented with exact details in the form of descriptions, drawings or photos.
- The scale version number and V### number (see type code) are allocated by NORIS.
- Please note that indicators with 360° dials are described in an extra data sheet (see DB-NIQ31).

Type code NIR3..., NIQ3...

NI	Indicator from the NORIMETER product family		
Housing type	Q	Square	
	R	Round	
Series	3	Fixed number for series (indicator generation)	
Housing size	-072	Square, body 72 x 72 mm	
	-096	Square, body 96 x 96 mm	
	-144	Square, body 144 x144 mm	
	-060	Round, body Ø 60 mm	
	-080	Round, body Ø 80 mm	
	-100	Round, body Ø 100 mm	
	-130	Round, body Ø 130 mm	
Input signal	-F1	Frequency, pulsating direct voltage, 0.2 Hz ... 140 KHz	
	-F2	Frequency, alternating voltage, 0.2 Hz ... 140 KHz	
	-FD1	Frequency, pulsating direct voltage with integrated direction-of-rotation monitoring	
	-FD2	Frequency, pulsating alternating voltage with integrated direction-of-rotation monitoring	
	-H1	NTC thermistor 40 ... 120 °C	
	-H2	NTC thermistor 5 ... 70 °C	
	-H3	NTC thermistor 114 ... 200 °C	
	-H0	NTC thermistor, customer-specific compensation	
	-I1	Direct current 0 ... 20 mA	
	-I2	Direct current 4 ... 20 mA	
	-I4	Direct current -20 ...0... +20 mA	
	-I0	Direct current, customer-specific compensation	
	-Px	Pt100; 2-wire (x = measuring range, see pos. x below)	
	-PxL3	Pt100; 3-wire (x = measuring range, see pos. x below)	
	-PxL4	Pt100; 4-wire (x = measuring range, see pos. x below)	
	-PTx	Pt1000; 2-wire (x = measuring range, see pos. x below)	
	-PTxL3	Pt1000; 3-wire (x = measuring range, see pos. x below)	
	-PTxL4	Pt1000; 4-wire (x = measuring range, see pos. x below)	
	x	1	0 ... 120 °C
		2	0 ... 150 °C
		3	0 ... 200 °C
		4	0 ... 250 °C
		5	0 ... 300 °C
		6	0 ... 400 °C
		7	0 ... 500 °C
		8	0 ... 600 °C
		11	-30 ... 120 °C
		12	0 ... 100 °C
		0	Customer-specific compensation
		-U1	DC voltage, 0 ... 10 VDC
		-U2	DC voltage, 2 ... 10 VDC
		-U4	DC voltage, -10 ...0... +10 VDC
	-U0	DC voltage, customer-specific compensation	
	-UG0	DC voltage, customer-specific compensation for tachogenerator GE1214	
Scale version	-123	Measuring range, scale type, etc.	
Cust.-specific indicator	V456	Customer-specific indicator	
Approval	-MED	GL MED approval for shipbuilding	
NI	3	Example: NIQ3-072-F1-123-MED	

Scale design - order assistance

Note: Please note that the design code listed below is not an order number and also not part of the product type code. This information is used as order assistance and should be provided in addition to the desired product type in the type code. Note that white and black scale dial are listed in separated tables.

White scale dial - Design code for scale look											
Scale dial	W	White illuminated scale dial									
Scaling type	0	Standard: Coarse graduation (e. g. Fig. 2 in 'Scale and pointer')									
	1	Orientation graduation (e. g. Fig. 1 in 'Scale and pointer')									
Scale curve	0	Standard: Without curve, scale and scale markings only									
	1	Wide curve									
	2	Narrow curve (e. g. Fig. 2 in 'Scale and pointer')									
	X	Customised scale curves on request									
Direction of rotation / Rotation angle	0	Standard: Clockwise, maximum 240°									
	1	Clockwise, maximum 300°									
	2	Counterclockwise, maximum 240°									
	3	Counterclockwise, maximum 300°									
Scale and scale markings	0	Standard: Black scale and scale marking									
	X	Option: Scale and scale marking in any colour									
Pointer variants	0	Standard: pointer black, unlighted									
	1	Red pointer, red illuminated when illumination is on									
	2	Yellow pointer, yellow illuminated when illumination is on									
	X	Customised illuminated pointer on request									
Customer logo	0	Standard: NORIS logo									
	X	Customer logo									
Zero point	0	Standard: Zero point left end									
	1	Standard: Zero point centred (left/right deflection)									
	X	Customised zero point									
Pointer return point	0	Standard: Return point is the mechanical zero point, below the electrical zero point (only for indicators with left or right stop)									
	X	Customised return point									
Design Code	W	0	0	0	0	1	0	0	0	0	Example: W00001000

Black scale dial - Design code for scale look										
Scale dial	S	Black illuminated scale dial								
Scaling type	0	Standard: Coarse graduation (e. g. Fig. 5 in 'Scale and pointer')								
	1	Orientation graduation (e. g. Fig. 6 in 'Scale and pointer')								
Scale curve	0	Standard: Without curve, scale and scale markings only								
	1	Wide curve (e. g. Fig. 10 in 'Scale and pointer')								
	2	Narrow curve								
	X	Customised scale curves on request								
Direction of rotation / Rotation angle	0	Standard: Clockwise, maximum 240°								
	1	Clockwise, maximum 300°								
	2	Counterclockwise, maximum 240°								
	3	Counterclockwise, maximum 300°								
Scale and scale markings	0	Standard: white illuminated scale and scale marking								
	X	Option: Scale and scale marking in any colour								
Pointer variants with illumination	0	Standard: White pointer, red illuminated when illumination is on								
	1	White pointer, white illuminated when illumination is on								
	2	White pointer, yellow illuminated when illumination is on								
	3	Yellow pointer, yellow illuminated when illumination is on								
	4	Red Pointer, red illuminated when illumination is on								
	X	Customised illuminated pointer on request								
Customer logo	0	Standard: NORIS logo								
	X	Customer logo								
Zero point	0	Standard: Zero point left end								
	1	Standard: Zero point centred (left/right deflection)								
	X	Customised zero point								
Pointer return point	0	Standard: Return point is the mechanical zero point, below the electrical zero point (only for indicators with left or right stop)								
	X	Customised return point								
Design Code	S	0	0	0	0	1	0	0	0	Example: S00001000