



SM 800 - series

800 watt DC POWER SUPPLY

SM 7.5-80 0 - 7.5 V 0 - 80 A
SM 18-50 0 - 18 V 0 - 50 A

Autoranging

SM 70-AR-24 0 - 35 V 0 - 24 A
 0 - 70 V 0 - 12 A

SM 400-AR-4 0 - 200 V 0 - 4 A
 0 - 400 V 0 - 2 A

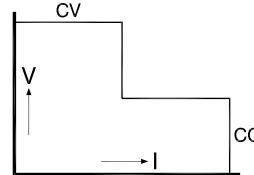
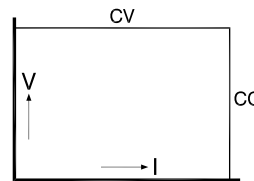

- Efficiency up to 89 %.
- Weight only 5.4 kg
- Wide input voltage range: 90 - 265 V AC, 48-62 Hz
- Active Power Factor Correction, PF=0.99
- 100 kHz MOSFET power conversion technique
- 0 - 5 V analog programmable (on both voltage and current)
- Isolated analog programming with optional ISO AMP CARD, to prevent earth loops
- **Ethernet, IEEE488** or **RS232** programming with optional internal interface cards
- Very low HF-emission, OK for **light** industrial environment, immunity OK for **industrial** environment

- Very low output ripple and spikes
- Very stable output voltage or current ($6 \cdot 10^{-5} - 10^{-4}$)
- Excellent dynamic response to load changes
- Master / Slave parallel and series operation with equal current and voltage sharing
- Designed for long life at full power
- Protected against all overload and short circuit conditions
- V and I control with 10-turn potentiometers, resolution 0.03 %. Optional with digital encoders
- Silent blower, only runs when needed, variable speed
- 48 hours burn-in

	SM 7.5-80	SM 18-50	SM 70-AR-24	SM 400-AR-4
Output				
voltage	0 - 7.5 V	0 - 18 V	0 - 70 V	0 - 400 V
current	0 - 80 A	0 - 50 A	0 - 24 A	0 - 4 A
AUTORANGING (2 ranges) max. output current / voltage	no -	no -	yes 24 A / 0-35 V 12 A / 35-70 V	yes 4 A / 0-200 V 2 A / 200-400 V
Input				
AC single phase, 48 - 62 Hz	90 - 265 V	90 - 265 V	90 - 265 V	90 - 265 V
<i>Power Derating vs input:</i>		<i>Vo = 16 V</i> <i>Vo = 18 V</i>		
90 V : P _{out max} (W), I _{in} (A)	580, 8.5	725, 10 670, 9.2	740, 10	750, 10
100 V : P _{out max} (W), I _{in} (A)	600, 7.6	800, 9.9 730, 8.9	830, 10	800, 9.5
110 V : P _{out max} (W), I _{in} (A)	600, 6.9	800, 8.8 770, 8.4	840, 9	800, 8.5
230 V : P_{out max} (W), I_{in} (A)	600, 3.2	800, 4.1 900, 4.5	840, 4.2	800, 4
power factor, 100%, 50% load	0.99, 0.96	0.99, 0.98	0.99, 0.98	0.99, 0.98
internal fuses	12.5 AT	12.5 AT	12.5 AT	12.5 AT
standby input power (V _o =I _o =0)	14 W	14 W	14 W	14 W
standby input power (V _o =V _{max})	18 W	18 W	20 W	26 W
			35 V / 70 V	200 V / 400 V
Efficiency				
AC 230 V input, full load	82 %	87 %	89 %	89 %
AC 115 V input, max. load	80 %	83 %	85 %	86 %
Regulation				
Load 0 - 100% CV	0.2 mV	0.5 mV	2 mV	10 mV
Line 120 - 265 V AC CV (measured on sense block)	0.2 mV	0.2 mV	0.5 mV	2 mV
Load 0 - 100% CC	4 mA	3 mA	1.5 mA	0.5 mA
Line 120 - 265 V AC CC (internal voltage sense)	1 mA	1 mA	1 mA	0.2 mA
Ripple + noise				
rms (BW=300 kHz) CV	2.5 mV	2 mV	3 mV	15 mV
p-p (BW=50 MHz) CV	10 mV	8 mV	15 mV	80 mV
rms (BW=300 kHz) CC	25 mA	5 mA	3 / 1 mA	0.8 / 0.5 mA
p-p (BW=50 MHz) CC	120 mA	25 mA	15 / 5 mA	3 / 1.5 mA
<i>CC-ripple at full load</i>				
Front panel connection	<i>Not available</i>	<i>Option 257</i>	<i>Option 258</i>	<i>Option 259</i>
Load Regulation: Load 0 - 100% CV	-	15 mV	40 mV	15 mV
Ripple + noise rms (BW=300 kHz) CV	-	3 mV	4 mV	18 mV
p-p (BW=50 MHz) CV	-	18 mV	20 mV	150 mV
Temp. coeff., per °C CV CC			35.10 ⁻⁶ 60.10 ⁻⁶	
Stability after 1 hr warm-up during 8 hrs CV CC			6.10 ⁻⁵ 9.10 ⁻⁵	
t _{amb} = 25 ± 1 °C, V _{in} = 230 V AC (int. voltage sensing for CC-stab.)				
Analog Programming	CV		CC	
Programming inputs				
input range	0 - 5 V		0 - 5 V	
accuracy	± 0.2%		± 0.5%	
offset	- 0.1 ... +1.3 mV (on 5V)		0 ... +2.2 mV (on 5V)	
temp. coeff. offset	10 μV / °C		50 μV / °C	
input impedance	> 1 MOhm		> 1 MOhm	
Monitoring output				
output range	0 - 5 V		0 - 5 V	
accuracy	± 0.2%		± 0.5%	
offset	- 1... 0 mV (on 5V)		- 1.1... 0 mV (on 5V)	
temp. coeff. offset	3 μV / °C		60 μV / °C	
output impedance	2 Ohm / max. 4 mA		2 Ohm / max. 4 mA	
Reference voltage on prog. connector V _{ref} TC	5.114 V ± 15 mV (R _o = 2 Ohm, max. 4 mA) 20 ppm			
+12 V output on prog. Connector V _o I _{max} R _o	12 V ± 0.2 V 0.2 A 3 Ohm			

Relay Outputs ACF DCF	AC - Fail DC - Fail ¹⁾	both NO and NC contact both NO and NC contact	¹⁾ output voltage \pm 5% beyond set point
Status outputs CC - status LIM - status OT - status PSOL - status ACF - status DCF - status	CC - operation CV- or CC-limit Over Temperature Power Sink Overload AC - Fail DC - Fail ²⁾	5 V = logic 1 ($R_o = 500 \text{ Ohm}$) 5 V = logic 1 ($R_o = 500 \text{ Ohm}$) 5 V = logic 1 ($R_o = 500 \text{ Ohm}$) 5 V = logic 1 ($R_o = 500 \text{ Ohm}$) 5 V = logic 1 ($R_o = 500 \text{ Ohm}$) 5 V = logic 1 ($R_o = 500 \text{ Ohm}$)	²⁾ output voltage \pm 5% beyond set point
Remote ShutDown	with + 5V, 1 mA or relay contact		
Interlock	contact at rear panel, see photo of rear panel on page 1-6		
Indicators (front panel)	Voltage meter, Ampere meter, AC-Fail, DC-Fail, Over Temperature, Power Sink Overload, Remote-ShutDown, Remote-CV, Remote-CC, Output On, CV-limit, CC-limit, CV- and CC- mode		
Controls (front panel)	Mains on/off switch, CV-and CC-potmeter, CV- and CC-limit-potmeter, Display-Settings button, Display-Limits button, Remote/Local button, Output On/Off button, Front panel Lock buttons.		

Programming speed <i>Standard Version</i>	SM 7.5-80	SM 18-50	SM 70-AR-24	SM 400-AR-4
Rise time (10 - 90%) output voltage step time, (100 % load) time, (10 % load)	0 \rightarrow 7.5 V 6.5 ms 2.5 ms	0 \rightarrow 16 V 12 ms 5 ms	0 \rightarrow 35 V 6 ms 2.5 ms	0 \rightarrow 200 V 4 ms 2 ms
output voltage step time, (100 % load) time, (10 % load)	- - -	- - -	0 \rightarrow 70 V 10 ms 7 ms	0 \rightarrow 400 V 8 ms 5 ms
Fall time (90 - 10%) output voltage step time, (100 % load) time, (10 % load)	7.5 \rightarrow 0 V 6.5 ms 62 ms	16 \rightarrow 0 V 12 ms 120 ms	35 \rightarrow 0 V 6 ms 60 ms	200 \rightarrow 0 V 4 ms 42 ms
output voltage step time, (100 % load) time, (10 % load)	- - -	- - -	70 \rightarrow 0 V 25 ms 250 ms	400 \rightarrow 0 V 15 ms 155 ms
Programming speed <i>High speed Version</i>	SM 7.5-80 <i>Option P250</i>	SM 18-50 <i>Option P251</i>	SM 70-AR-24 <i>Option P252</i>	SM 400-AR-4 <i>Option P253</i>
Rise time (10 - 90%) output voltage step time, (100 % load) time, (10 % load)	0 \rightarrow 7.5 V 0.2 ms 0.2 ms	0 \rightarrow 16 V 0.22 ms 0.26 ms	0 \rightarrow 35 V 0.24 ms 0.24 ms	0 \rightarrow 200 V 0.4 ms 0.3 ms
output voltage step time, (100 % load) time, (10 % load)	- - -	- - -	0 \rightarrow 70 V 0.24 ms 0.24 ms	0 \rightarrow 400 V 0.82 ms 0.55 ms
Fall time (90 - 10%) output voltage step time, (100 % load) time, (10 % load)	7.5 \rightarrow 0 V 0.2 ms 1 ms	16 \rightarrow 0 V 0.24 ms 1.95 ms	35 \rightarrow 0 V 0.27 ms 3 ms	200 \rightarrow 0 V 0.42 ms 4.6 ms
output voltage step time, (100 % load) time, (10 % load)	- - -	- - -	70 \rightarrow 0 V 0.85 ms 9.5 ms	400 \rightarrow 0 V 1.7 ms 20 ms
Ripple @full load (rms/pp) @full load (rms/pp)	20 / 80 mV	40 / 120 mV	35 V / 24 A 25 / 90 mV 70 V / 12 A 30 / 110 mV	200 V / 4 A 35 / 200 mV 400 V / 2 A 30 / 160 mV
Output capacitance	310 μ F	200 μ F	80 μ F	4 μ F

Notes: All specifications regarding programming speed are typical and measured on a resistive load.

	SM 7.5-80	SM 18-50	SM 70-AR-24	SM 400-AR-4
Recovery time recovery within di/dt of load step output voltage time, @ 50 - 100% load step max. deviation @ 230 V AC input voltage	50 mV 1.25 A/ μ s 7 V 100 μ s 160 mV	60 mV 0.9 A/ μ s 15 V 100 μ s 150 mV	35 V / 70 V 75 mV 0.4 / 0.2 A/ μ s 30 / 65 V 100 μ s 250 / 200 mV	200 V / 400 V 1 / 0.5 V 0.1 / 0.05 A/ μ s 185 / 370 V 100 μ s 2 / 1.5 V
Output impedance CV, 0-1 kHz CV, 1-100 kHz	< 1 m Ω < 30 m Ω	< 2 m Ω < 30 m Ω	< 7 m Ω < 35 m Ω	< 0.18 Ω < 2 Ω
Pulsating load max. tolerable AC component of load current f > 1 kHz f < 1 kHz	15 Arms 80 Apeak	15 Arms 50 Apeak	10 Arms 12 / 24 Apeak	0.4 Arms 2 / 4 Apeak

Insulation input / output creepage / clearance input / case output / case	3750 Vrms (1 min.) 8 mm 2500 Vrms 600 V DC
Safety	EN 60950 / EN 61010
EMC Power Supply Standard Generic Emission Generic Immunity	EN 61204-3 , Emission: residential, light industrial environment (CISPR22-Class B) Immunity: industrial environment EN 61000-6-3 , residential, light industrial environment (EN 55022 B) EN 61000-6-2 , industrial environment
Operating Temperature at full load	- 20 to + 50 °C derate output to 75% at 60 °C
Humidity	max. 95% RH, non condensing, up to 40 °C max. 75% RH, non condensing, up to 50 °C
Storage temperature	- 40 to + 85 °C
Thermal protection	Output shuts down in case of insufficient cooling
MTBF	500 000 hrs

Hold-Up time $V_{out} = 100\%$, $P_{out} \leq 840\text{ W}$ $V_{out} = 85\%$, $I_{out} = 100\%$ $V_{out} = 100\%$, $I_{out} = 50\%$ @ 230 V AC input	16 ms 20 ms 36 ms (time till DC-fail = 1)
Turn on delay after mains switch on	600 ms @ 230 V AC, 900 ms @ 115 V AC
Inrush current	24 A @ 115 V AC, 22 A @ 230 V AC

Series operation max. total voltage Master / Slave operation	600 V yes			
Parallel operation max. total current Master / Slave operation	no limit max. 4 units (including master)			
Remote sensing max. volt. drop per load lead	2 V			
Limits Voltage adjust range Current adjust range	0 - 102% 0 - 102%			
Potentiometers & Encoders front panel control with knobs resolution screwdriver adjustment digital encoders	standard 0.03 % Option P001 (at front panel) Option P236			
	SM 7.5-80	SM 18-50	SM 70-AR-24	SM 400-AR-4
Meters scale voltage scale current accuracy read output read limit setting (d = digit)	3.5 digit 0 - 7.50 V 0 - 80.0 A 0.5% + 2 d 2% + 2 d	3.5 digit 0 - 18.00 V 0 - 50.0 A 0.5% + 2 d 2% + 2 d	3.5 digit 0 - 70.0 V 0 - 24.0 A 0.5% + 2 d 2% + 2 d	3.5 digit 0 - 400 V 0 - 4.00 A 0.5% + 2 d 2% + 2 d

Mounting	Stacking of units allowed, air flow is from rear to the sides.
Input Connector	IEC320/C14, EN 60320/C14
Output Terminals	M5 bolts
Programming connector	15 pole D-connector at rear panel (FEMALE)
Cooling audio noise level airflow	Low noise blower, fan speed adapts to temperature of internal heatsink. ca. 45 dBA at full load, 25 °C ambient temperature, 1 m distance ca. 50 dBA at full load, 50 °C ambient temperature, 1 m distance from rear to sides
Enclosure degree of protection	IP20
Dimensions behind front panel: h x w x d front panel: h x w	86 x 221 x 406 mm (feet removed) 88.1 x 222 mm (1/2 19", 2 U)
Weight	5.4 kg

Digital Encoders

OPTION P236

- CV and CC encoders with a very long life time and intelligent functions (e.g. Keylock).

Screwdriver adjustment standard potentiometers

OPTION P001

- CV and CC knobs are moved backwards to avoid accidental adjusting.

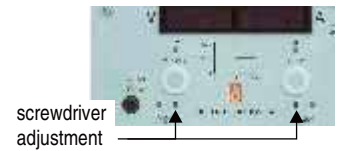

Master / Slave operation

- Parallel and Series operation with equal Current and Voltage sharing.
- This way two or more SM-units can be used together as one high power unit.
- Voltage and current of the units is controlled by the master (by potentiometers or by programming).
- Easy to connect in Master / Slave mode, using standard UTP-cables (RJ45).
Standard on all SM800 units, no special option required.

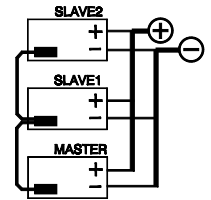

Battery Charging

- The CV / CC regulated power supplies are ideal battery chargers. Once set at the correct output voltage, the battery will charge constantly without overcharging. This can be useful for **emergency power systems**.
- Use a circuit-breaker in series to protect the internal diode from reverse connection of the battery.
- The SM400-AR-4 needs an **external diode set** on the output as extra protection for the internal diode.
- *Ordering information for diode set: SM400-AR-4 OPTION P201*



Download the special datasheet for more details from 'www.DeltaPowerSupplies.com' (on the OPTIONS-page).

Increased max. output voltage/current

OPTION P069

- The maximum output voltage or current can be increased by approximately 10%. Normally this results in a derating of the maximum ambient temperature or other parameters.
- Always add increased value for voltage or current in ordercode, for example **SM70-AR-24 P069 output 75 V**.
- Note: for the SM18-50 only the current can be increased by 10%, not the voltage.

For exact details consult the technical department, email 'Support@Delta-Elektronika.nl'.

Enforced secondary insulation 1000 V

OPTION P089

- The secondary insulation between output and ground is increased from standard 600 V to 1000 V .

High Speed Programming

- The speed is **10 - 20 times higher** because of the smaller output capacitors.
- Relatively low current overshoots (if any) in case of sudden voltage variations caused by the load, this is of great advantage for laser diode applications.

Applications:

- **Laser diode** power supply, continuous or pulsed.
- Test systems requiring a fast settling time to improve throughput of factory.
- A constant current source with a low parallel capacitance: plasma, load sensitive to current overshoots, etc.
- A constant current source on a load with **fast voltage variations**.
- *Ordering information:*

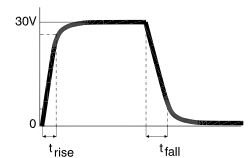

	SM 7.5-80	SM 18-50	SM 70-AR-24	SM 400-AR-4
Option	P250	P251	P252	P253

Download the special datasheet for more details from 'www.DeltaPowerSupplies.com'.

Power Sink for 2 quadrant operation

- Can absorb continuous power of **140 W**.
- Maintains output voltage regardless output power is positive or negative (source & sink).
- Ideal solution for supplying **electric motors** with PWM-speed control.
- Fast down programming at no load conditions.
- *Ordering information:*

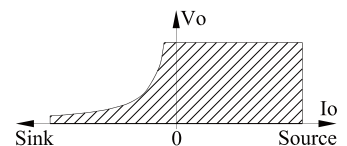

	SM 7.5-80	SM 18-50	SM 70-AR-24	SM 400-AR-4
Option	P245	P246	P247	P248

Download the special datasheet for more details from 'www.DeltaPowerSupplies.com'.

Built-in Ethernet Power Supply Controller

OPTION P256

Built-in RS232 Power Supply Controller

OPTION P254

Built-in IEEE488 Power Supply Controller

OPTION P255

Built-in ISO AMP CARD for isolated analog programming

OPTION P249

Note: there is only room for one of the interfaces in a unit (P249, P254, P255, P256)

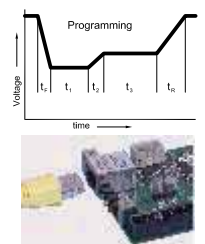

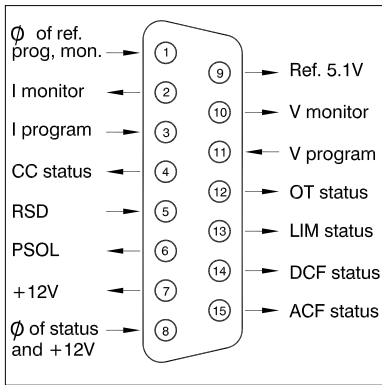

Connections programming connector

CV = Constant Voltage
 CC = Constant Current

 Specifications measured at
 $t_{amb} = 25 \pm 5^\circ C$ and $V_{in} = 230 V AC$,
 50 Hz, unless otherwise noted.

 The information in this document is
 subject to change without notice

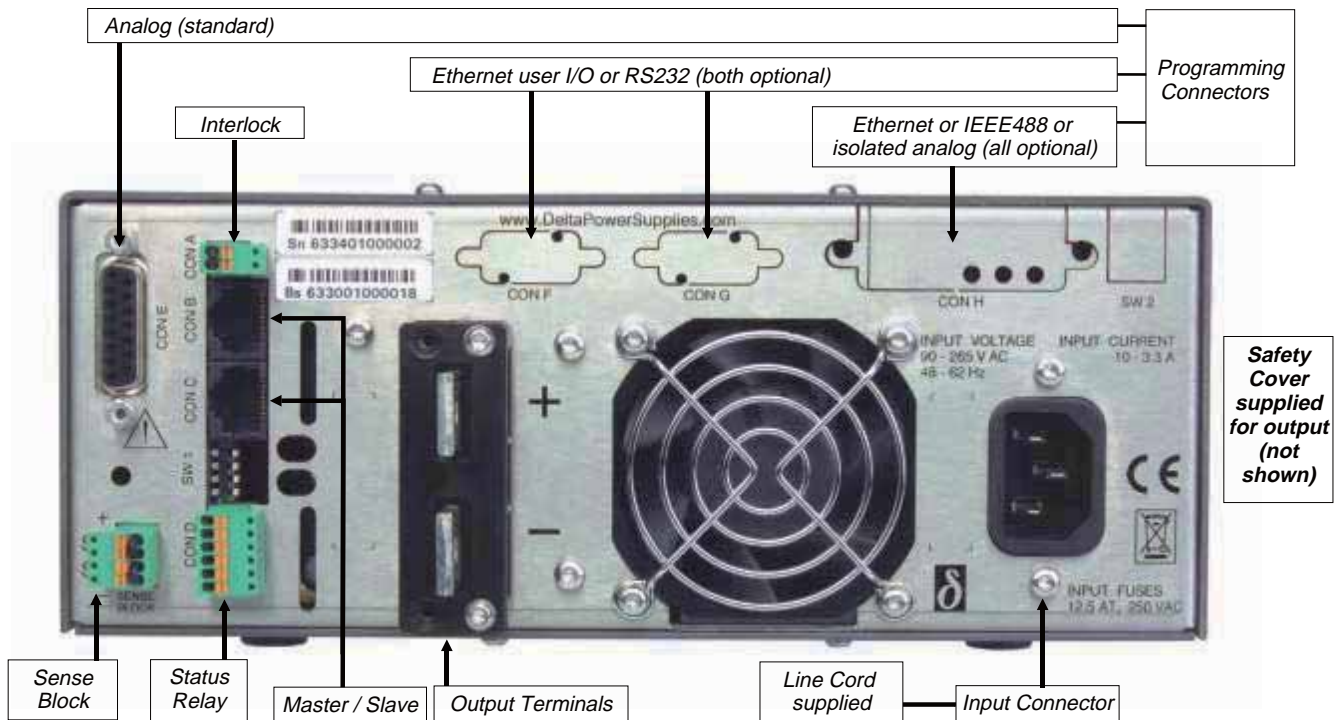
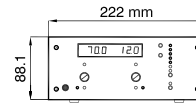
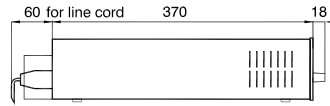
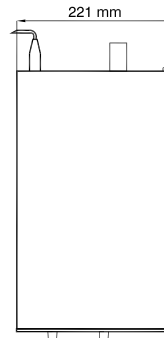

Front panel connection
 SM18-50 Opt. 257 - SM70-AR-24 Opt. 258
 SM400-AR-4 Opt. 259



19" Rack Adapter RA19-2SM800

